



Accessory Products



Scaffolds Series

NU-WAVE
SCAFFOLDING SYSTEMS

Classic

Model #660

69-1/2" Ladders, 6' Platform and Trusses

- Scaffold components made in the USA
- Easy Set Up
- Load Capacity of 1000 lbs.
- Rolls through standard door openings
- All Steel Construction
- Adjusts in 4" increments



Prod#	Description	Ship Wt.
48545	660 Classic With PIC-5	145

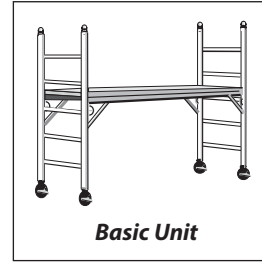

Scaffold Parts and Accessories

NU-WAVE
SCAFFOLDING SYSTEMS

Guardrail Kits

For your safety, always use guardrails at any working height. They are recommended equipment when using any scaffold.

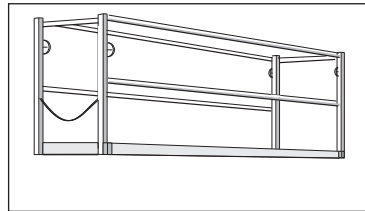

Product #	Model #	Description	Ship Wt.
48660	GK-6	Guardrail Kit—6 ft. Scaffold 2-GR2&2-GR6	68

Plywood Platform

5/8 inch thick plywood with 1/32 inch galvanized banding. The banding is fixed to the plywood to provide permanent protection.

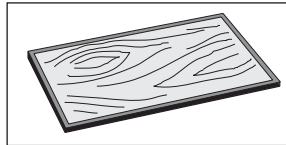

Product#	Model#	Description	Ship Wt.
49015	PP-6CL	Classic 6 ft. (28.5" x 70.25")	24

* Locking Platform

Casters

INDY CASTERS feature a unique self-adjusting locking mechanism. A streamlined lever design permits 360 degree wheel rotation.

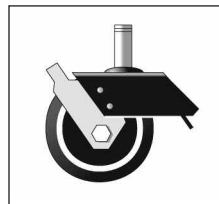

PIC-5

Product#	Model#	Description	Ship Wt.
49040	PIC-5	5" INDY Caster-Swivel&Wheel Brake	5



Mini-Scaffolds

Model SU-4

4 Ft. Step-Up® Portable Mini-Scaffold

With its sturdy 1" O.D. tubular construction, 500 lb. load capacity and 50" height, the SU-4 is perfect for all low ceiling jobs. The SU-4 comes with 5" INDY All Brake Casters which permit 360 degree wheel rotation for ease of movement. Folds down to just 22" wide.



Prod#	Description	Load Cap	Ship Wt.
48035	4 ft. Step-Up Mini-Scaffold with 4 #PC54B-5" all brake casters 51.5" high x 48" long x 22" wide	500	70

Model SU-5

5 Ft. Step-Up® Portable Mini-Scaffold

Throw away those bulky, shaky ladders, A-frames and planks! Whatever job you're up to, the SU-5 will help you do it faster, safer and easier. The SU-5 is adjustable to four convenient working heights, has a 600 lb. load capacity, and features INDY All Brake Casters.



Prod#	Description	Load Cap	Ship Wt.
48037	5 ft. Step-Up Mini-Scaffold with 4 #PC54B-5" all brake casters 61.5" high x 56" long x 25" wide	600	90

Model SU-6

6 Ft. Step-Up® Portable Mini-Scaffold

By popular demand...a taller version of Nu-Wave's Step-Up Utility Work Stand! Like all of Nu-Wave's Mini-Scaffolds, the SU-6 sets up in seconds with no assembly required. Adjusts to six working heights up to six feet. Features include "high tech" cushion rubber locking swivel INDY casters and big 600 lb. load capacity.



Prod#	Description	Load Cap	Ship Wt.
48039	6 ft. Step-Up Mini-Scaffold with 4 #PC54B-5" all brake casters 72" high x 56" long x 25" wide	600	100



Drywall Carts

NU-WAVE
SCAFFOLDING SYSTEMS

Model PD-1 Residential Drywall Cart

This residential drywall cart has a streamline design, ergonomic handle, and is lightweight.

- 2000 lb. load capacity
- 17.25" wide x 47" high x 39.25" long

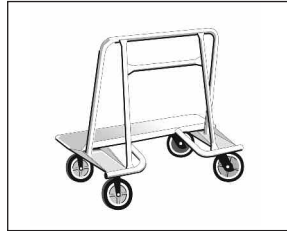

Product #	Model #	Description	Ship Wt.
49090	PD-1	Without Casters	50

Model PD-2

For most applications, this economical model is all you need to do the job. Two wheels are fixed position for straight ahead movement. Two wheels swivel for turning. Like all the other drywall carts, it's built to last with quality.

- 3,000 lb. load capacity
- 22" wide x 47" high x 43.625" long



Product #	Model #	Description	Ship Wt.
49100	PD-2	Without Casters	50

Model PD-4

This model features a special inset back tube frame. It provides maximum maneuverability around tight corners or through standard doorways with four swivel casters. Optional position locks keep two wheels straight when moving one direction.

- 3,000 lb. load capacity
- 25" wide x 47" high x 49.75" long



Product #	Model #	Description	Ship Wt.
49240	PD-4	Without Casters	75

INDY Casters for Drywall Carts

NU-WAVE
SCAFFOLDING SYSTEMS

Custom built for Nu-Wave, these are the strongest, longest-lasting casters in the industry. All wheels are 8" x 2". The frame features an all heat-treated bearing race with celcon seals. A unique new king pin design spreads stress points for longer-lasting caster frames.

Product #	Model #	Description	Unit	Ship Wt.
49337	PCHTS-8-S	8" Swivel Hi-Tech Caster	EA	6

Hi-Tech Silverline

- rolls easily-very durable
- protects floors, rejects floor debris
- low temperature flexibility
- chemical, steam and water resistant
- 2400 lb. capacity





TRIGGER Benches and Platforms

Aluminum Bench

- Heavy-duty aluminum
- Solid rivet construction
- Non-slip foot pads
- Heavy-duty aluminum spreader hinges

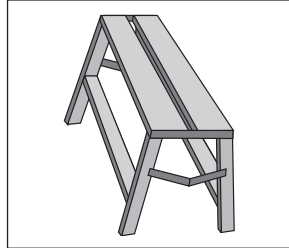

Prod #	Size	Qty/Unit	Unit	Wt/Unit
71135	30"L x 24" H	1	EA	10
71140	30"L x 30" H	1	EA	12
71145	30"L x 36" H	1	EA	15
71150	30"L x 48" H	1	EA	20
71152	30"L x 60" H	1	EA	25
71153	30"L x 72" H	1	EA	30

Fat Top

- 9-1/2" Top Step
- Meets all OSHA requirements for under 4'
- Heavy-duty bolted hinge and spreader
- 3" Step
- Heavy-duty 1A 300lb. Rating

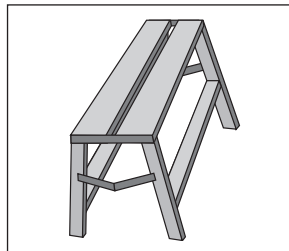

Prod #	Size	Qty/Unit	Unit	Wt/Unit
71180	30"L x 24" H	1	EA	12
71185	30"L x 30" H	1	EA	14
71190	30"L x 36" H	1	EA	17
71195	30"L x 48" H	1	EA	24

Extendible Plank

- Heavy-duty aluminum
- Solid rivet construction
- 4 sizes, expands from 6' to 9', 7' to 11', 8' to 13' and 10' to 16'

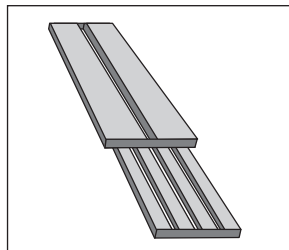

Prod #	Size	Qty/Unit	Unit	Wt/Unit
71160	7' - 11'	1	EA	42
71165	8' - 13'	1	EA	48
71167	10' - 16'	1	EA	55



Respirators

3M Particulate Respirator 8210 Plus, N95

- NIOSH approval: N95
- Recommended for sanding and working with fiberglass insulation and drywall sanding
- Adjustable nose clip helps provide a custom fit, a secure seal and reduces eyewear fogging

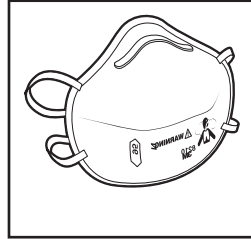

Prod#	Qty/Box	Box/Ctn	Unit	Wt/Ctn
62020	20	4	CTN	2.8

3M Particulate Respirator 8511, N95

- NIOSH approval: N95
- Recommended for sanding and working with fiberglass insulation and drywall sanding
- Cool flow exhalation valve allows easy exhalation and heat reduction, which provides cool, dry comfort

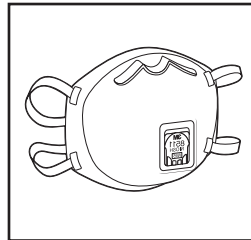

Prod#	Qty/Box	Box/Ctn	Unit	Wt/Ctn
62040	10	4	CTN	3

Abrasives



Sanding Sponges

Sanding Sponges

- Small area sponge for wet or dry sanding
- Rinse and reuse
- Ideal for sanding wood, paint, metal, plastic or drywall
- Two sanding grades on one sponge



Prod#	Model#	Desc	Pcs/Ctn	Unit	Wt/Ctn
61400	#908	Fine/Medium	24	CTN	2

Size: 2-5/8" X 3-3/4" X 1"

Detail Area/Angled Sanding Sponges

- Use either wet or dry and when finished, rinse and reuse
- Designed to sand corners without affecting adjacent walls or textured ceilings
- Medium (80 grit) and Fine (120 grit)



Prod#	Model#	Desc	Pcs/Ctn	Unit	Wt/Ctn
61720	#CP041	Medium	24	CTN	3
61730	#CP040	Fine	24	CTN	3

Size: 2-7/8" X 4-7/8" X 1"

Sandpaper and Sanding Screens



Smooth-Kut Paper

Available in 80 grit to 150 grit grades, this sandpaper features D-weight backing for strength with flexibility and longer life in drywall finishing. The 4 3/16" x 11" sheets actually measure 11-1/4" in length for improved mounting on pole sanders.



Prod#	Model#	Grit	Sht/Box	Box/Ctn	Unit	Wt/Ctn
52070	B0308	80 grit	100	10	CTN	34
52080	B0307	100 grit	100	10	CTN	29
52090	B0306	120 grit	100	10	CTN	26
52100	B0305	150 grit	100	10	CTN	26

Wet-Kut Waterproof Cloth

100 percent waterproof, this strong J-weight cloth is the same material that is used to make "denim" type jeans, thereby giving it unsurpassed durability in the abrasive field. It is ideal for "wet sanding", and can be washed off if loading occurs. The 3 5/16" x 12" sheets fit sanders without trimming, and easily mount on pole and hand sanders.

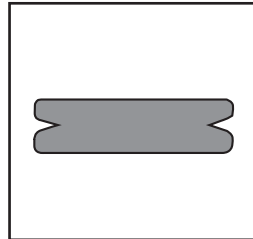

Prod#	Model#	Grit	Sht/Box	Box/Ctn	Unit	Wt/Ctn
52130	B0905	100 grit	25	10	CTN	21
52135	B0904	120 grit	25	10	CTN	21
52140	B0903	150 grit	25	10	CTN	21
52145	B0902	180 grit	25	10	CTN	21
52147	B0901	240 grit	25	10	CTN	21

Sanding Sponges



Sanding Sponges

Compact and flexible abrasive coated sponges are convenient and economical for general sanding of drywall, wood and metal surfaces. Featuring dual-grades in either fine (120 grit), medium (80 grit), or coarse (50 grit). Can be rinsed and reused.

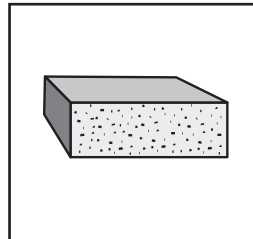

Prod#	Model#	Desc	Pcs/Ctn	Unit	Wt/Ctn
52110	B1101D	Fine/Medium	30	CTN	2.3

Size: 3-3/4" x 2-3/4" x 1"

Dual Angled Sanding Sponges

Large flexible abrasive sponges feature two 75 degree beveled sides and fine/medium grading for multi-purpose use. Suitable for general sanding of flat or contoured surfaces as well as allowing sanding into corners or up to trim and moldings.

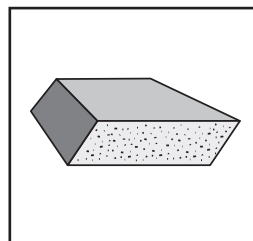

Prod#	Model#	Grit	Pcs/Ctn	Unit	Wt/Ctn
52125	B1107	Fine/Medium	24	CTN	2.5

Size: 5" x 3" x 1"



Masking Tape

#2020 General Purpose Masking Tape

- For general purpose masking
- High adhesion for good holding power
- Provides good paint lines
- 1 day clean removal



Bulk pack.

Prod#	Width	Rls/Ctn	Unit	Wt/Ctn
67032	1"	36	CTN	14
67034	1-1/2"	24	CTN	14
67036	2"	24	CTN	17

#2090 SCOTCH Brand Long Mask Masking Tape

- Medium adhesion; UV and sunlight resistant
- Use also on most previously painted surfaces, including painted wallboard
- Excellent for masking exterior glass enameled or varnished woodwork
- IMPROVED! 14 day clean removal

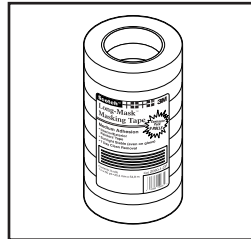

Bulk pack.

Prod#	Width	Rls/Ctn	Unit	Wt/Ctn
67050	1"	36	CTN	14
67060	1-1/2"	24	CTN	13.5
67070	2"	24	CTN	17.6

Poly Duct Tape



Polyken 827

Premium Grade Poly Duct Tape

High-density, polyethylene tape with high shear, conformability, abrasion and chemical resistance, and moisture barrier properties. Sticks to most surfaces, including polyethylene films, and leaves no residue when removed. (2" width, 8 mil.)

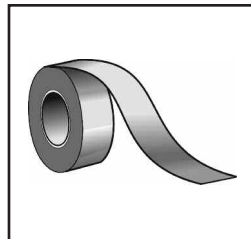

Prod#	Item	Width	Rolls/Ctn	Ctns/Plt	Unit	Wt/Ctn
69030	827	2"	24	27	CTN	28

Cloth Duct Tape



Polyken 223

Utility Grade Cloth Duct Tape

Featuring patented Kappa Calendar Construction, this utility grade cloth duct tape with high adhesion qualities is excellent for general use. 10 mil thickness. 2" width.

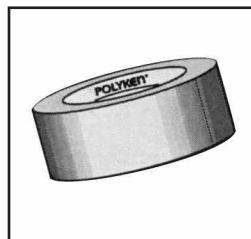

Prod#	Item	Width	Rolls/Ctn	Ctns/Plt	Unit	Wt/Ctn
69020	223	2"	24	27	CTN	44



Plastic Construction Films



Plastic Sheeting

Whatever your plastic sheeting need, Poly-America has you covered. Made of high-quality polyethylene, Poly-America Plastic Sheeting delivers unsurpassed durability, performance and versatility every roll, every time.

- * Polyethylene
- * Available in a variety of lengths, widths and thicknesses
- * Suitable for masking, vapor barriers, flashing and more

Prod#	Item #	Mil	RI Size	Aprox Wt/RI	Unit	Rls/Pallet
60010	109C	1	9' x 400'	17	RL	80
60030	2100C	2	8'4" x 200'	16	RL	96
60040	212C	2	12" x 200'	23	RL	64
60060	420C	4	20' x 100'	38	RL	35
60098	620C	6	20' x 100'	57	RL	20

Painter's Plastic (High Density)

Costs less than conventional low-density sheeting. It is thinner, has better tape adhesion, and comes in a convenient dispenser.

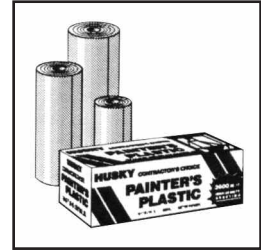

Prod#	Item #	Mil	RI Size	Aprox Wt/RI	Unit	Rls/Pallet
60092	03509H	0.31	9' x 400'	6	RL	140
60093	03512H	0.31	12' x 400'	8	RL	112

Hand Wrap Stretch Film

Essential for all warehouses, Hand Wrap Stretch Film gives you total quality control over your shipping. 80 gauge.

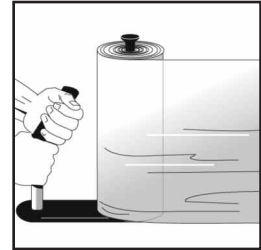

Prod#	Item #	RI Size	Aprox Wt/Ctn	Unit	Rls/Ctn
61010	HW181580	18" x 1500'	35	CTN	4



Masking Papers, Floor Paper

Handmasker Masking Paper

A general purpose Kraft paper, suitable for all kinds of masking needs. Packaged in 180 ft. rolls for easy handling.

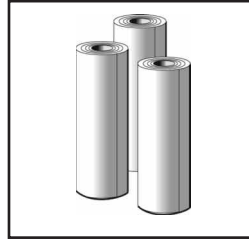

Prod#	Size	Lgth	Rolls/Ctn	Unit	Wt/Ctn	Ctns/Pallet
58950	6"	180 ft	12	CTN	9	119
58960	9"	180 ft	12	CTN	14	85
58970	12"	180 ft	12	CTN	18	68
58990	18"	180 ft	12	CTN	27	40

Contractor's Paper

A heavy duty construction paper used to protect floors from spills and over spray.

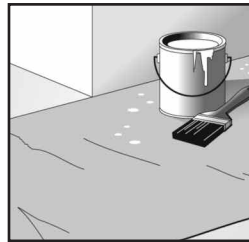

Prod#	Size	Lgth	Rolls/Ctn	Unit	Wt/RI	Rls/Pallet
58900	36"	166 ft	1	RL	12	80

Floor Paper

A 50 lb. Kraft paper designed to protect large areas from over spray, spills and foot traffic. 3" core.

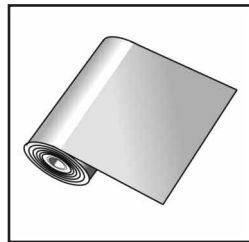

Prod#	Size	Lgth	Rolls/Ctn	Unit	Wt/Ctn	Ctns/Pallet
58905	48"	825 ft	1	RL	55	35

Hand Masker Film, Dispenser and Blades



Pre-folded Masking Film Rolls

- Cut labor spend covering window by 50%!
- Folded film unfolds to sizes between 4' and 12'
- Specially formulated to resist paint flaking during multiple coat application
- One person application using a 3M Handmasker™

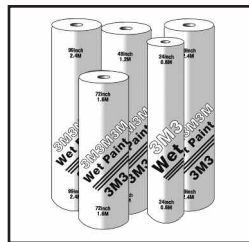

Prod#	Size	Rls/Ctn	Unit	Wt/Ctn
64100	48" x 180'	12	CTN	19
64110	72" x 90'	12	CTN	16

M3000 Handmasker™ Dispenser

- Designed for professional contractors
- Simultaneously applies pre-folded masking film or paper with masking tape to cover and protect
- Designed for heavy duty masking

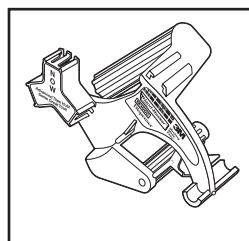

Prod#	Model#	Pcs/Ctn	Unit	Wt/Ctn
62500	M3000	4	CTN	6



Adhesives & Sealants



F-38 Green Series

Drywall Construction Adhesive

Professional grade, latex based construction adhesive designed for drywall and other panel applications. This ultra-low VOC product offers fast strength development and high shear strength.



Prod#	Size	Tubes/Ctn	Units/Pallet	Unit	Wt/Unit
54032	28 oz. Tube	12	60	CTN	34

Specifications:

- Tested per ASTM E 72 — Racking Load Evaluation of Sheathing Materials on a Standard Wood Frame
- GreenGuard® certified and Qualifies for LEED® points
- Meets and conforms to the performance characteristics of ASTM C 557
- Complies to the following VOC regulations: SCAQMD Rule 1168 VOC, CARB, BAAQMD

SC-175 Green Series

Sound Sealant

A non-flammable, latex-based sealant specially designed to reduce sound transmissions and drafts in all types of wall systems where a sound-rated assembly is required. The paintable sealant remains flexible and adheres firmly to wood, metal studs, concrete, and most other building materials.



Prod#	Size	Tubes/Ctn	Units/Pallet	Unit	Wt/Unit
54020	28 oz. Tube	12	60	CTN	40

Specifications:

- Tested to or conforms to: ASTM E 84: Surface Burning Characteristics of Building Materials, ASTM E 90-85: Laboratory Measurement of Airborne-Sound Transmission Loss of Building Materials, ASTM D 217: Testing Standard for Consistency, ASTM C 919: Standard Practice for Use of Sealants in Acoustical Applications
- GreenGuard® certified and Qualifies for LEED® points
- Complies to the following VOC regulations: SCAQMD Rule 1168 VOC, CARB, BAAQMD

FRP-555

Latex FRP Panel Adhesive

A high quality, solvent free adhesive for installing fiberglass reinforced panels on common surfaces. Bonds to drywall, wood, concrete, metals, plastic, plastic foams, etc. Long open time with strong yet flexible bond. Nonflammable. Water-resistant.



Prod#	Size	Units/Pallet	Unit	Wt/Unit
54085	5 Gallon	24	PL	63

Specifications:

- Meets SCAQMD Rule 1168 VOC
- CARB and BAAQMD compliant

3M Spray Adhesive



Super 77 Spray Adhesive

- 220 sq. feet of coverage TWICE as much as the competition
- Used on corner bead where mechanical fasteners are impractical
- Fast, aggressive tack
- Meets California VOC requirements
- Bonds many foils, plastics, papers, foams, metals and cardboard

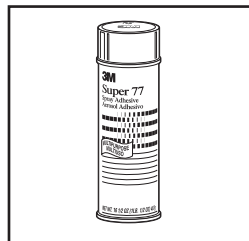

Prod#	Size	Cans/Ctn	Unit	Wt/Ctn
65010	16.5 oz	12	CTN	17.1

High Strength Spray Adhesive 90

- Fast drying contact adhesive
- Bonds high-pressure laminates, woods, particle boards, metals and plastics



Prod#	Size	Cans/Ctn	Unit	Wt/Ctn
65020	16.5 oz	12	CTN	18.2



Self-Adhesive Fiberglass Mesh Tape

Hamilton Self-Adhesive Fiberglass Mesh Tape

- Individually Shrink Wrapped
- Quick and Easy Installation
- Fiberglass Mesh
- No Shrinking, Bubbling or Stretching
- No Preparing or Stapling
- Made In USA



Prod#	Roll Size	Color	Rolls/Ctn	Unit	Wt/Ctn
50015	*2" X 300'	White	24	CTN	20
50025	*2" X 300'	Yellow	24	CTN	20

* Nominal Width (48 mm x 91.4 mm)

50040	2-1/2" X 300'	Yellow	24	CTN	22
50060	2-1/2" X 300'	Blue	24	CTN	22

Recommended Use... Apply first coat over glass mesh tape with Fast Set compound. Subsequent coats may be applied using vinyl based "ready mixed" compounds. Allow to dry between coats.

Self-Adhesive Custom Quality Mesh Tape

- Individually Shrink Wrapped
- Quick and Easy Installation
- Fiberglass Mesh
- No Shrinking, Bubbling or Stretching
- No Preparing or Stapling



Prod#	Roll Size	Color	Rolls/Ctn	Unit	Wt/Ctn
50010	*2" X 300'	White	24	CTN	20
50020	*2" X 300'	Yellow	24	CTN	20

* Nominal Width (48 mm x 91.4 mm)

Recommended Use... Apply first coat over glass mesh tape with Fast Set compound. Subsequent coats may be applied using vinyl based "ready mixed" compounds. Allow to dry between coats.

Caulking

Hamilton Detail Compound

- Use to detail interior angles
- Low shrinkage and easy sanding
- Paintable



Prod#	Size	Tubes/Ctn	Unit	Ship Wt.
55100	10.1 oz.	24	CTN	27



Aerosol Spray Texture

HOMAX Ultra-Fast Drying Orange Peel

- Oil-based formula
- Patches orange peel & splatter textures
- Ultra-fast drying
- Covers up to 110 sq. ft.



Prod #	Model #	Size	Cans/Box	Unit	Wt/Bx
72051	4055-06	20 oz.	6	Bx	10

HOMAX Knockdown

- Water-based, low-odor formula
- Sprays multiple patterns
- For patching Southwest or Mediterranean style textures
- Covers up to 60 sq. ft.



Prod #	Model #	Size	Cans/Box	Unit	Wt/Bx
72056	4065-06	20 oz.	6	Bx	10.5

HOMAX Color-Changing Orange Peel

- Water-based
- For repairing and patching interior heavy splatter or knockdown drywall textures
- Water clean-up
- Covers up to 90 sq. ft.



Prod #	Model #	Size	Cans/Box	Unit	Wt/Bx
72061	4096-06	16 oz.	6	Bx	10

**Changes color, blue to white.*

HOMAX Water-Based Orange Peel

- Water-based
- Water cleanup, low odor, fast drying
- Patches orange peel and splatter textures
- Covers up to 110 sq. ft.



Prod #	Model #	Size	Cans/Box	Unit	Wt/Bx
73016	4092-06	20 oz.	6	Bx	10.5



Drywall Fasteners



Insta-back Fastener

Insta-back fasteners make drywall repair quick and easy because cutouts can be reattached without cutting drywall back to the nearest stud (as shown in the illustrations below). Insta-backs make finished butt joints that are "bump free", and save time and money by reducing the number of joints to be finished. Meets all building codes and fire ratings.

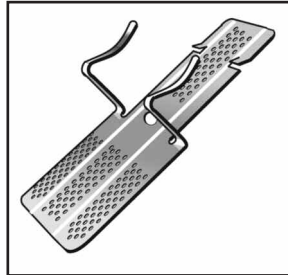

Prod#	Desc	Pcs/Ctn	Ctn/Pallet	Unit	Wt/Ctn
71010	1/2"	200	50	CTN	10
71020	5/8"	200	50	CTN	10

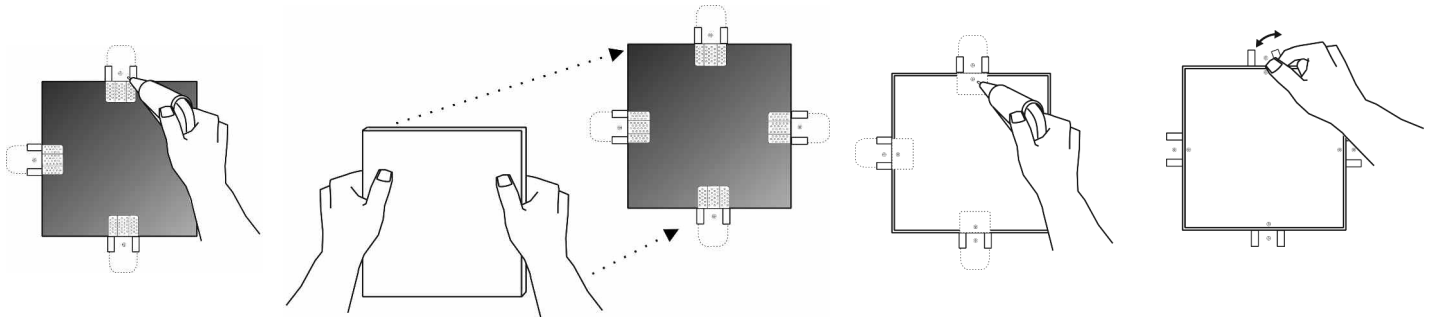

1. Place fasteners as shown and secure with drywall screws 3/4" from the edge.

2. Replace drywall patch in hole.

3. Screw through patch into Insta-back fasteners 3/4" from the edge.

4. Bend Insta-back tabs back and forth until they snap off.

Corner-back Fastener

Corner-back fasteners save you time, money and materials by allowing you to eliminate one stud at almost every corner. By eliminating the need for corner back-up studs, Corner-backs permit corners to be fully insulated (as shown in the illustration at right). This means a significant reduction in thermal loss. Corner-backs also reduce costly callbacks due to ceiling/partition separation from truss uplift. Meets all building codes and fire ratings.

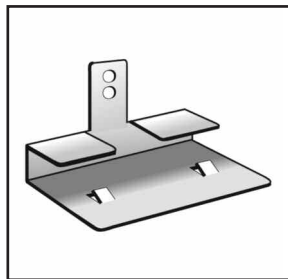

Prod#	Desc	Pcs/Ctn	Ctn/Pallet	Unit	Wt/Ctn
71030	1/2"	300	50	CTN	10
71040	5/8"	300	50	CTN	10

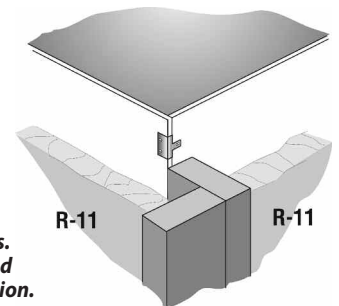

Corner-backs eliminate wood backup at corners and ceilings. The result is faster framing and faster, easier drywall installation.

295 North Pekin Road | Woodland, Washington 98674

Phone: (360) 225-6888 | Toll-Free Phone: (877) 443-7683 | Main Fax: (800) 871-5007 | CS Fax: (877) 5-FAX-HDP

www.hamiltonnw.com